

**ALEXANDRA  
NEWSPAPERS**

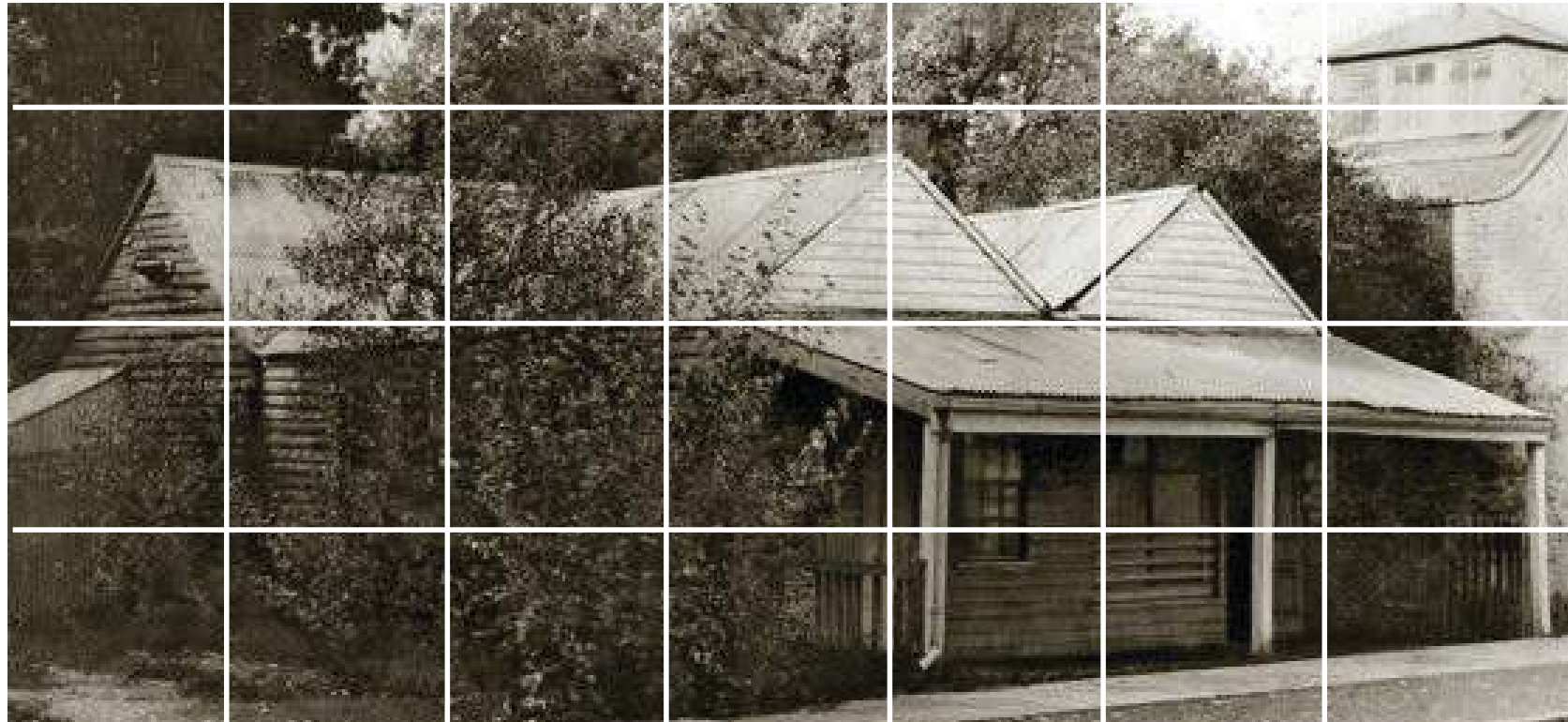

Pty. Ltd.



**Media Kit**

Call us today to discuss your requirements

# Sample Sizes and Prices

PUBLICATION DATES Weekly on Wednesday **BOOKING DEADLINE Thursday 5pm**

To book your space call 5772 1002 or email [1sales@alexandranewspapers.com.au](mailto:1sales@alexandranewspapers.com.au)

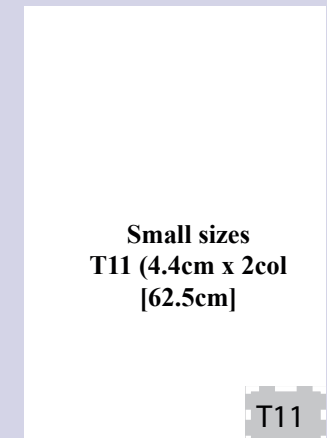
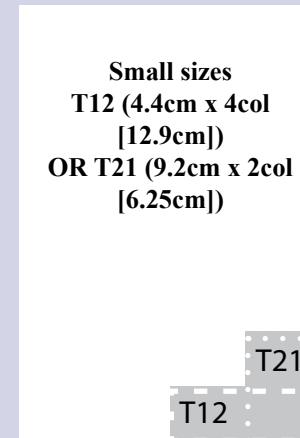
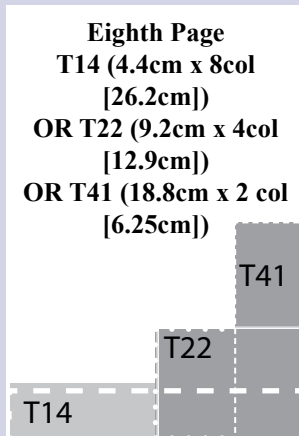
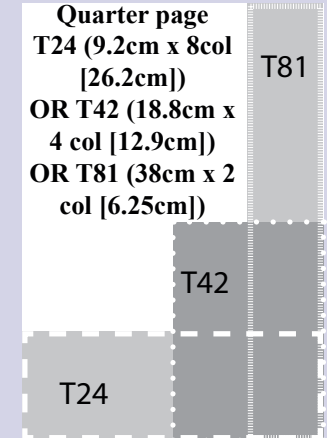
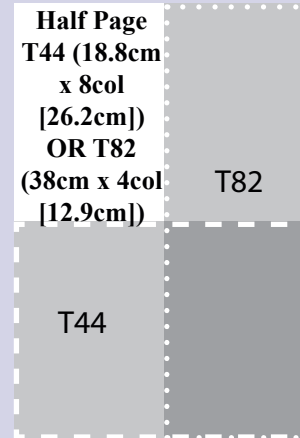
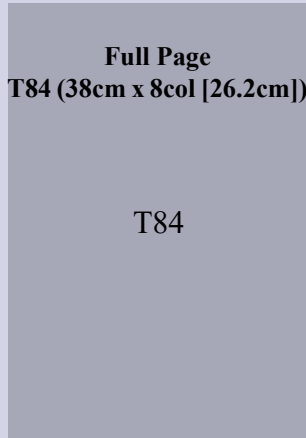

There is a loading charge for Front page (50%) and requests for page 3 (30%), page 5 (20%) or the back page (50%).

PUBLICATION DATES weekly on Wednesday **BOOKING DEADLINE** noon Thursday

To book your space call 5772 1002

Or email [reception@alexandranewspapers.com.au](mailto:reception@alexandranewspapers.com.au)

## The Xea Chronicle

*(google images are not acceptable as they are subject to copyright)*

**CHOOKIES FLOORING XTRA**

- < CARPET < BLINDS
- < VINYL < CURTAINS
- < TIMBER < RUGS

1 Hall Street ALEXANDRA  
t: 03 5772 2235



DWC0051

5cm X 2 column (6.25 cm)

**EZY Electrical Services**

REC 16959  
Prompt reliable service  
Phone Ian  
**0408 990 487**



EMC0076

4cm X 2 column (6.25 cm)

8cm X 2 column (6.25 cm)

**Boz Miljkovic**  
Mechanic

**Alexandra Automotive**  
VACC

61 Downey Street, Alexandra  
Ph (03) 5772 3232

- General Car Servicing
- Repairs & Tuning
- Batteries
- Road Worthy Certificates
- Disc & Drum Machining
- Front Ends & Suspension



K/MC0009

**Rock'n'Conc**

- Concrete cutting and sealing
- Decorative concreting
- 3.6 tonne excavator
- Exposed aggregate
- House slabs
- Shed slabs
- Driveways
- Tip truck
- Bob cat

**Luke Hill**

**0409 250 234**  
rocknconc@gmail.com

EMC1746

10cm X 2 column (6.25 cm)

**KEATH'S EXCAVATIONS P/L, YARCK**

**EARTH MOVING**

Excavators ~ Dozers ~ Graders  
Scrapers ~ Loaders ~ Rollers  
Backhoe ~ Water Carts  
Low Loader ~ Tippers  
Trucks & Trailers

All equipment operated by qualified operators  
PERSONAL SUPERVISION - 42 YEARS EXPERIENCE  
Phone 5773 4242 Mobile 0428 577 951  
[keathsexc@bigpond.com](mailto:keathsexc@bigpond.com)

EMC0082



6cm X 2 column (6.25 cm)

# For all your commercial printing needs



**ALEXANDRA**  
NEWSPAPERS

- Business cards
- Letterhead
- Flyers
- Envelopes
- Invoice books
- Receipt books
- Self inking Stamps
- Magnets
- Menus
- Address labels
- Signage
- Special Occasion cards
- Finishing services

43 Grant Street Alexandra **Ph 5772 1002** or email [print@alexandranewspapers.com.au](mailto:print@alexandranewspapers.com.au)

• **personal service** • **friendly staff** • **reliable** • **design service** • **free quotes**